



HOSHIZAKI

CERTIFICATION



HACCP International



ISO9001

FM-300AKS-HCN-SB-B-301SA

NUGGET ICE MAKER



Key Features



NATURAL
REFRIGERANTS

**Eco-Friendly
Refrigerant**



Easy for maintenance
Notify when parts should
be replaced

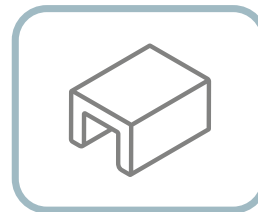

**Stainless Steel
Exterior**

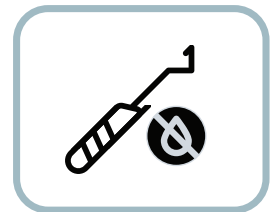

**Stainless Steel &
Greaseless Auger**

Our Flake & Nugget Ice Makers belong to the true allrounders of the Hoshizaki product line-up. These powerful, durable and sustainable machines are highly popular across different market segments, such as in food preparation / processing, as well as in hotels, bars, restaurants and catering businesses.



Dimensions & Specifications

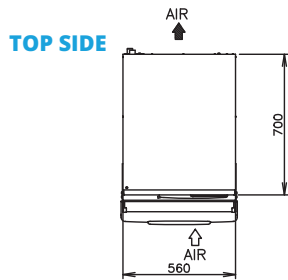

NUGGET ICE AIR SYSTEM

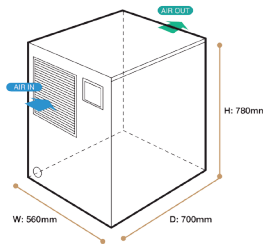

ICE SHAPE

NUGGET Compressed Flake Ice

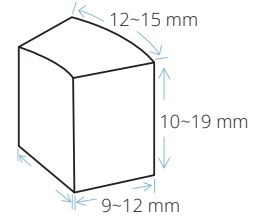

FRONT SIDE

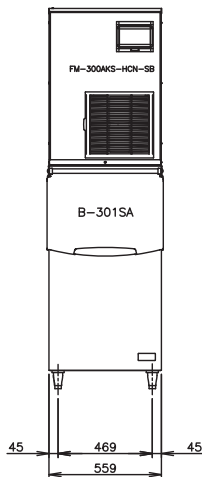

RIGHT SIDE

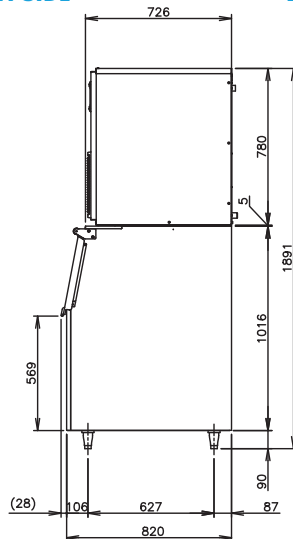

BACK SIDE

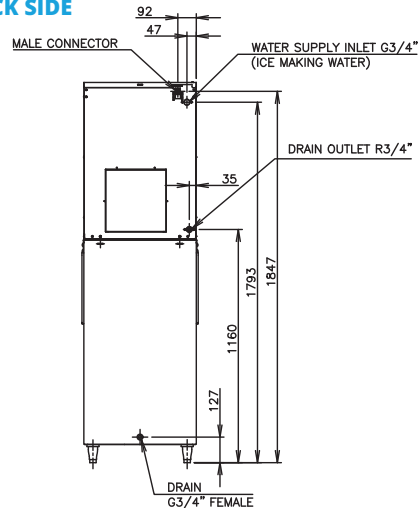

MODEL		FM-300AKS-HCN-SB-B-301SA
ICE SHAPE		Nugget Ice
POWER SUPPLY		1 Phase 220-240V 50Hz Capacity: 1.04kVA (4.7A)
AMPERAGE		4.7A Started: 16A
ELECTRIC CONSUMPTION		810W
HEAT REJECTION	(AT32°C / WT21°C)	1850W
ICE PRODUCTION PER 24H	(AT10°C / WT10°C)	275kg
	(AT21°C / WT15°C)	231kg
	(AT32°C / WT21°C)	189kg
STORAGE CAPACITY		Approx. 144kg
WATER CONSUMPTION PER 24H	(AT32°C / WT21°C)	187L
CONTAINER TYPE		Ice bin is not included
REFRIGERANT		R290 / 110g
OUTSIDE DIMENSIONS		560mm(W) x 820mm(D) x 1891(- 1921)mm(H)
PACKAGE		Ice Maker: Carton: 665 x 820 x 950mm Storage Bin: Carton: 655 x 924 x 1188mm
WEIGHT		Ice Maker: 80.5kg / 87.5kg Storage Bin: 37kg / 49kg
OPERATING CONDITIONS		Ambient Temp.:5-40°C, Water Supply Temp.:5-35°C, Water Supply Pressure: 0.05-0.8MPa, Voltage Range: Rated Voltage±10%



HOSHIZAKI

HOSHIZAKI (THAILAND) LIMITED

No. 99 CP Tower North Park building 9th Floor, Zone D1 Soi Ngamwongwan 47 Intersection 42, Thung Song Hong Subdistrict, Lak Si District, Bangkok 10210 Thailand
 TEL +66 2 005 9980 FAX +66 2 516 2646
<https://hoshizaki-sea.com/>

